

Small-Fry Showmanship

Show Date: 5-27

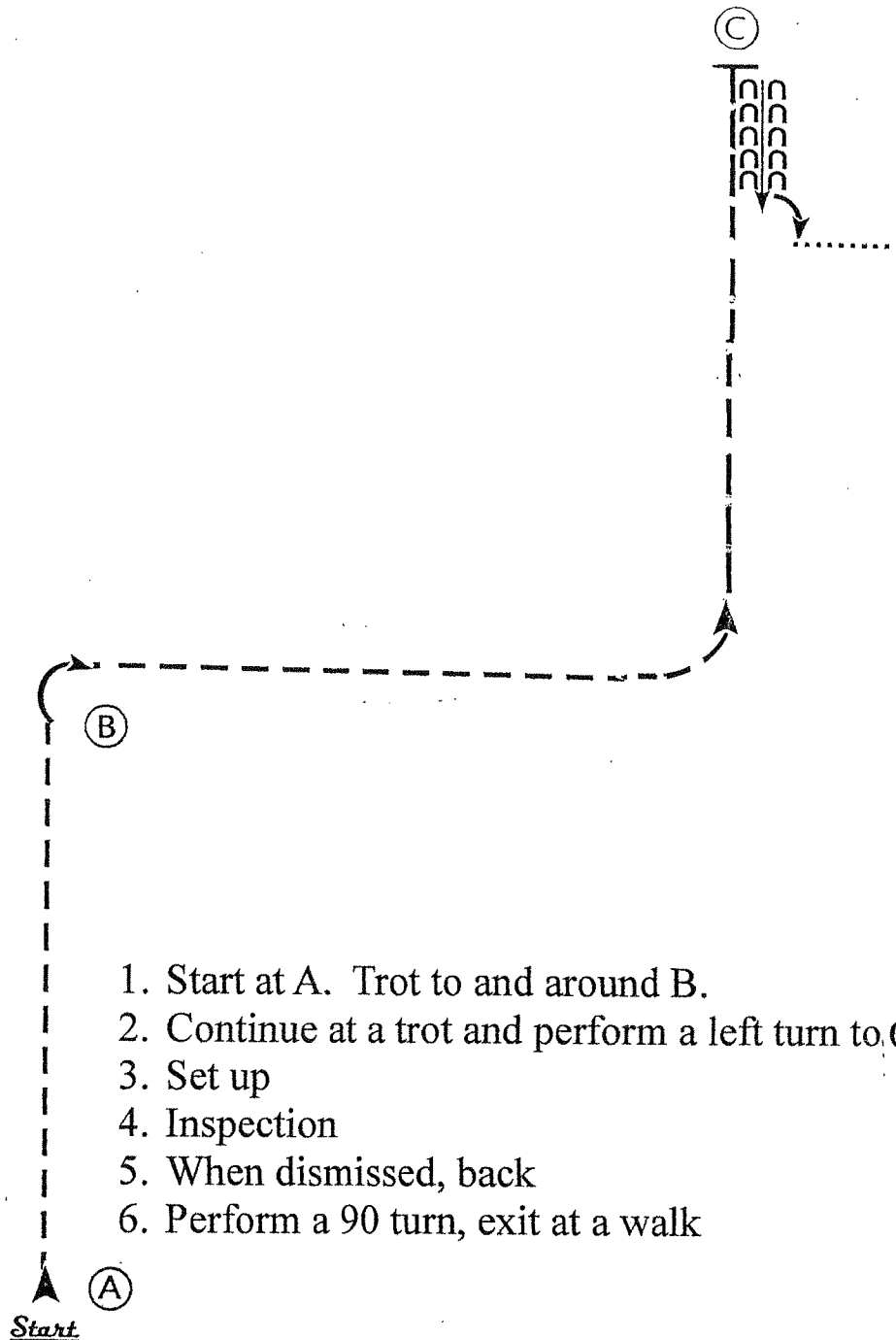

1. Start at A. Trot to and around B.
2. Continue at a trot and perform a left turn to C and stop.
3. Set up
4. Inspection
5. When dismissed, back
6. Perform a 90 turn, exit at a walk

Pattern Provided by:
The Judges

Level 1 Youth/Amateur Showmanship

Show Date: 5-27

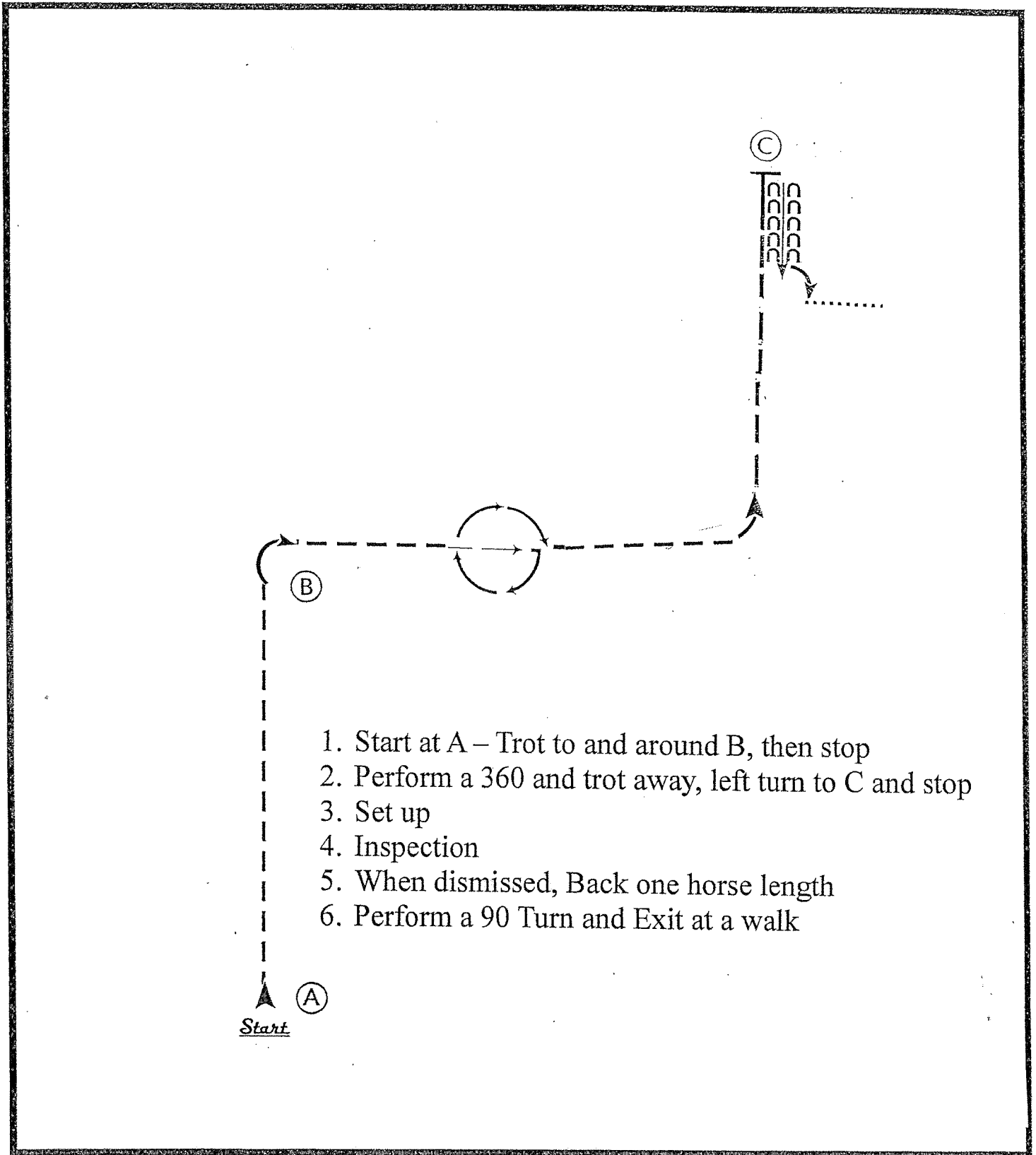

1. Start at A – Trot to and around B, then stop
2. Perform a 360 and trot away, left turn to C and stop
3. Set up
4. Inspection
5. When dismissed, Back one horse length
6. Perform a 90 Turn and Exit at a walk

Pattern Provided by:
The Judges

All Ages Open Youth/Amateur Showmanship

Show Date: 5-27

Select

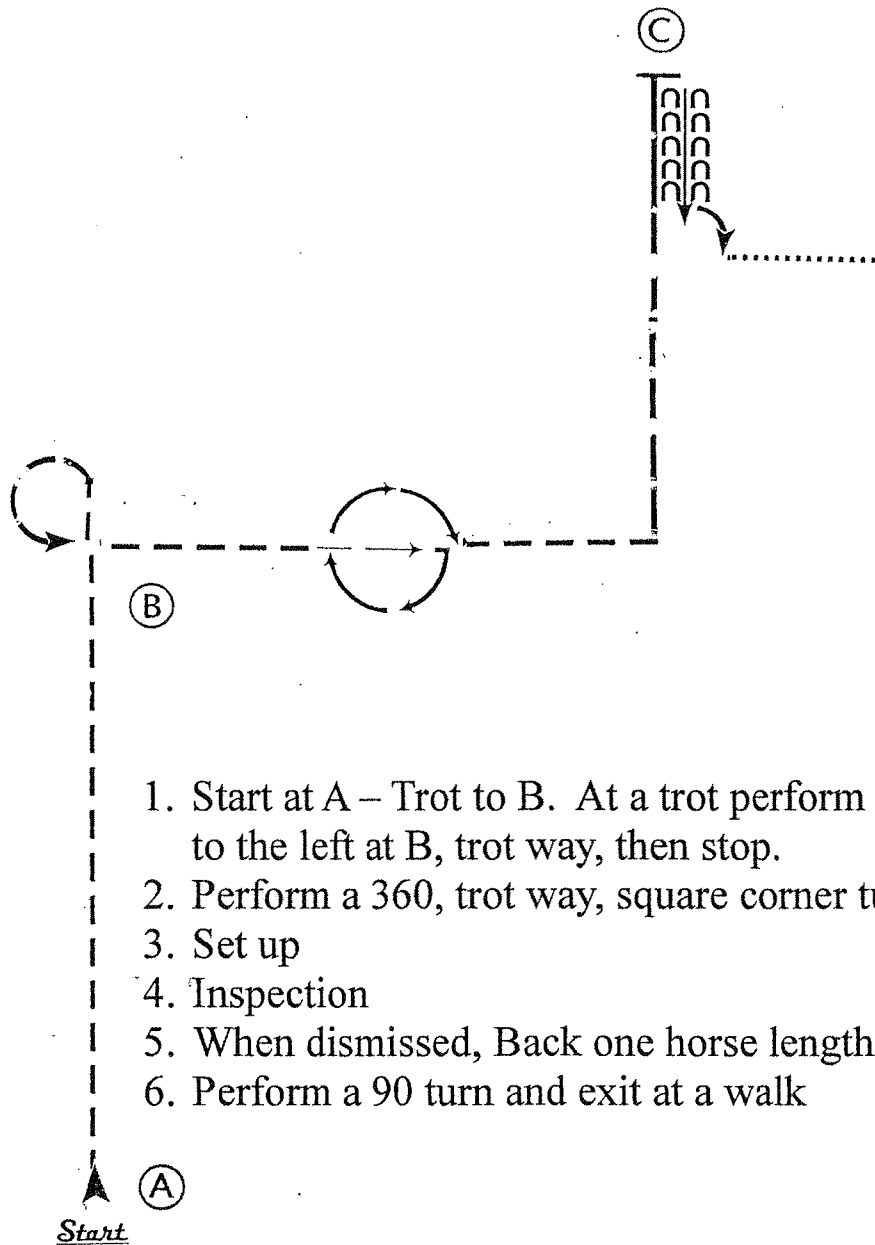

1. Start at A – Trot to B. At a trot perform a tight turn to the left at B, trot way, then stop.
2. Perform a 360, trot way, square corner turn to C and stop.
3. Set up
4. Inspection
5. When dismissed, Back one horse length
6. Perform a 90 turn and exit at a walk

Pattern Provided by:

The Judges

Small-Fry/Walk-Trot Equitation

Show Date: 5-27

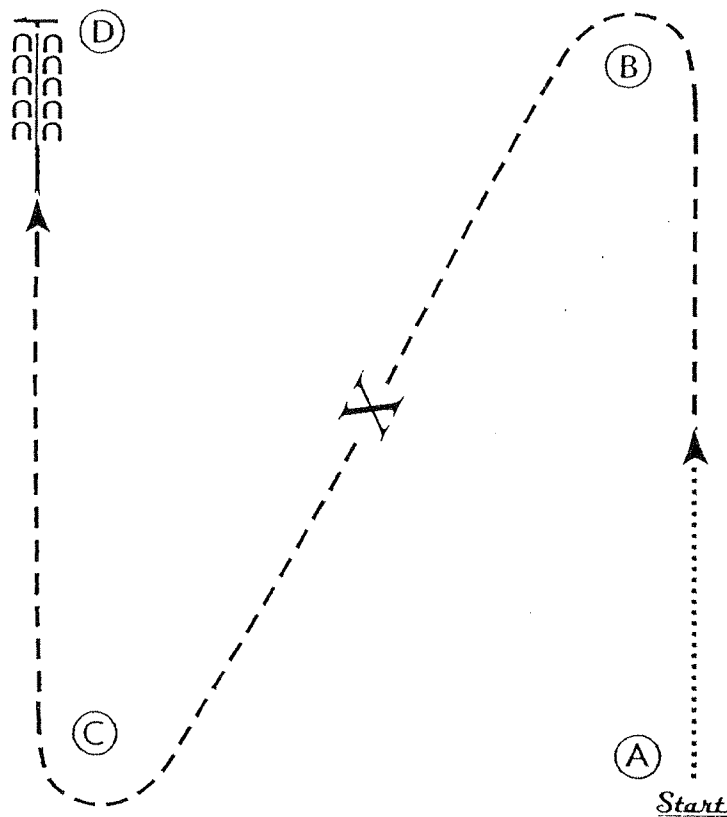

1. Begin at A. Walk 6 steps then trot right diagonal around B
2. Half way to C change diagonals.
3. After rounding C trot to D
4. Stop at D and Back
5. Exit at a sitting trot

Pattern Provided by:

The Judges

Level 1 Youth/Amateur Equitation

Show Date: 5-27

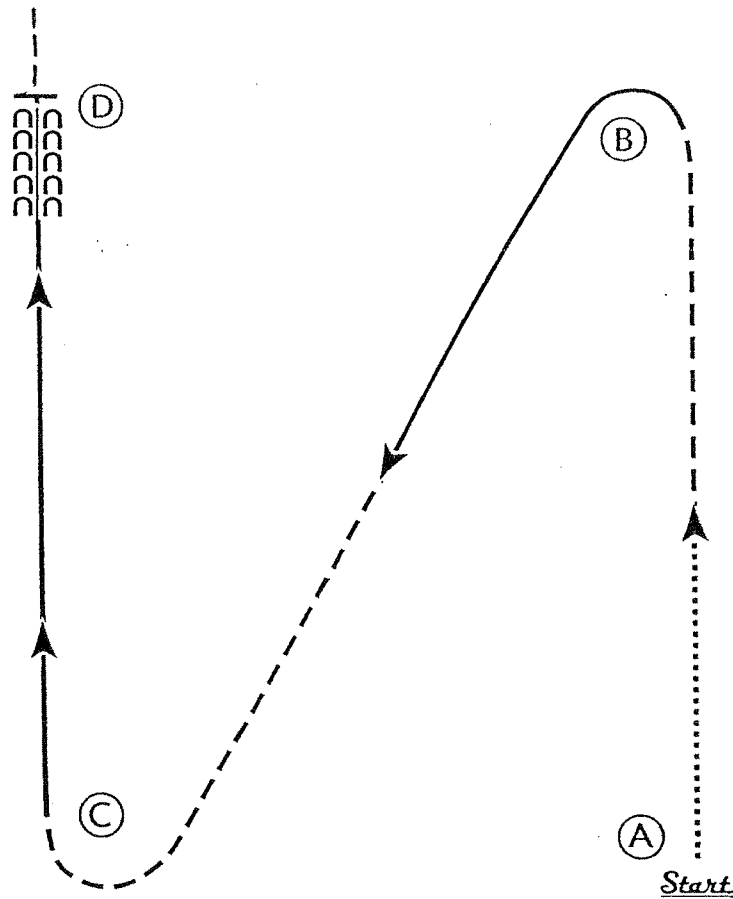

1. Begin at A. Walk one horse length, then sitting trot to B.
2. Canter left lead around B and $\frac{1}{2}$ way to C.
3. Then drop to a posting trot left diagonal
4. After rounding C canter on right lead to D
5. At D stop and back
6. Sitting trot to exit.

Pattern Provided by:

The Judges

All Ages Youth/Amateur Equitation

Show Date: 5-27

Select

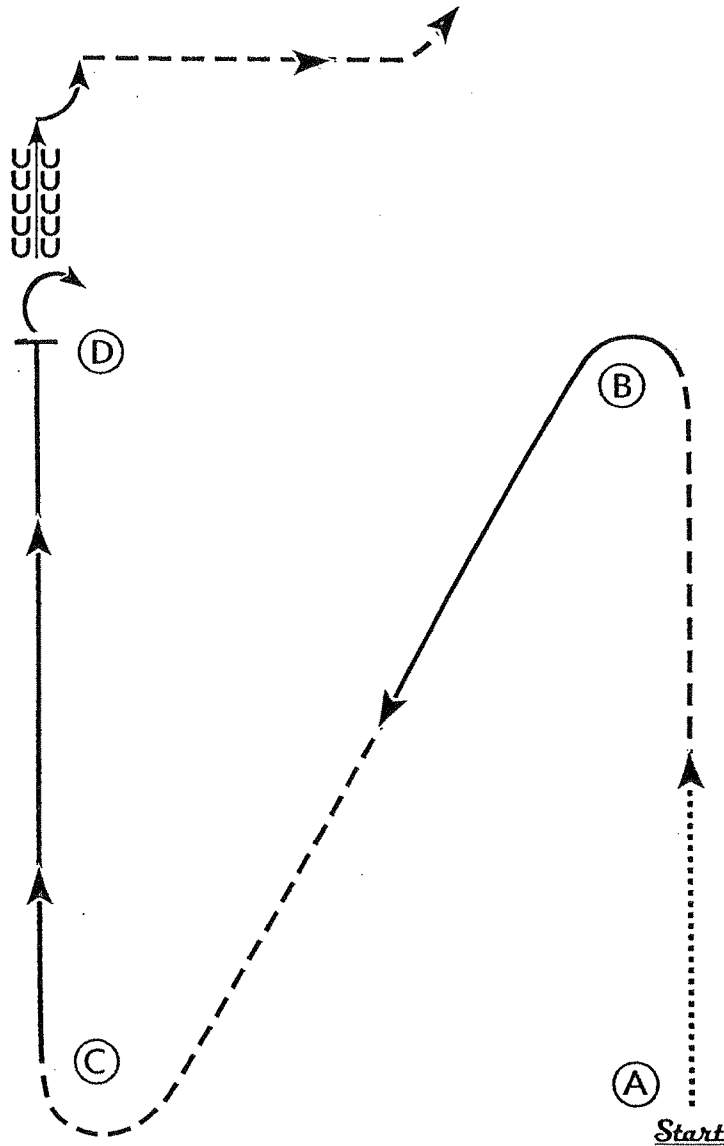

1. Begin at A. Walk one horse length, then sitting trot to B.
2. Canter left lead around B and $\frac{1}{2}$ way to C
3. Then drop to a posting trot left diagonal
4. After rounding C canter on right lead to D and stop
5. Turn a 180 on the forehand to the right and back.
6. Turn a 90 on the forehand to the left then exit at a sitting trot.

Pattern Provided by:
The Judges

Small-Fry/Walk-Trot Horsemanship

Show Date: 5-27

Select

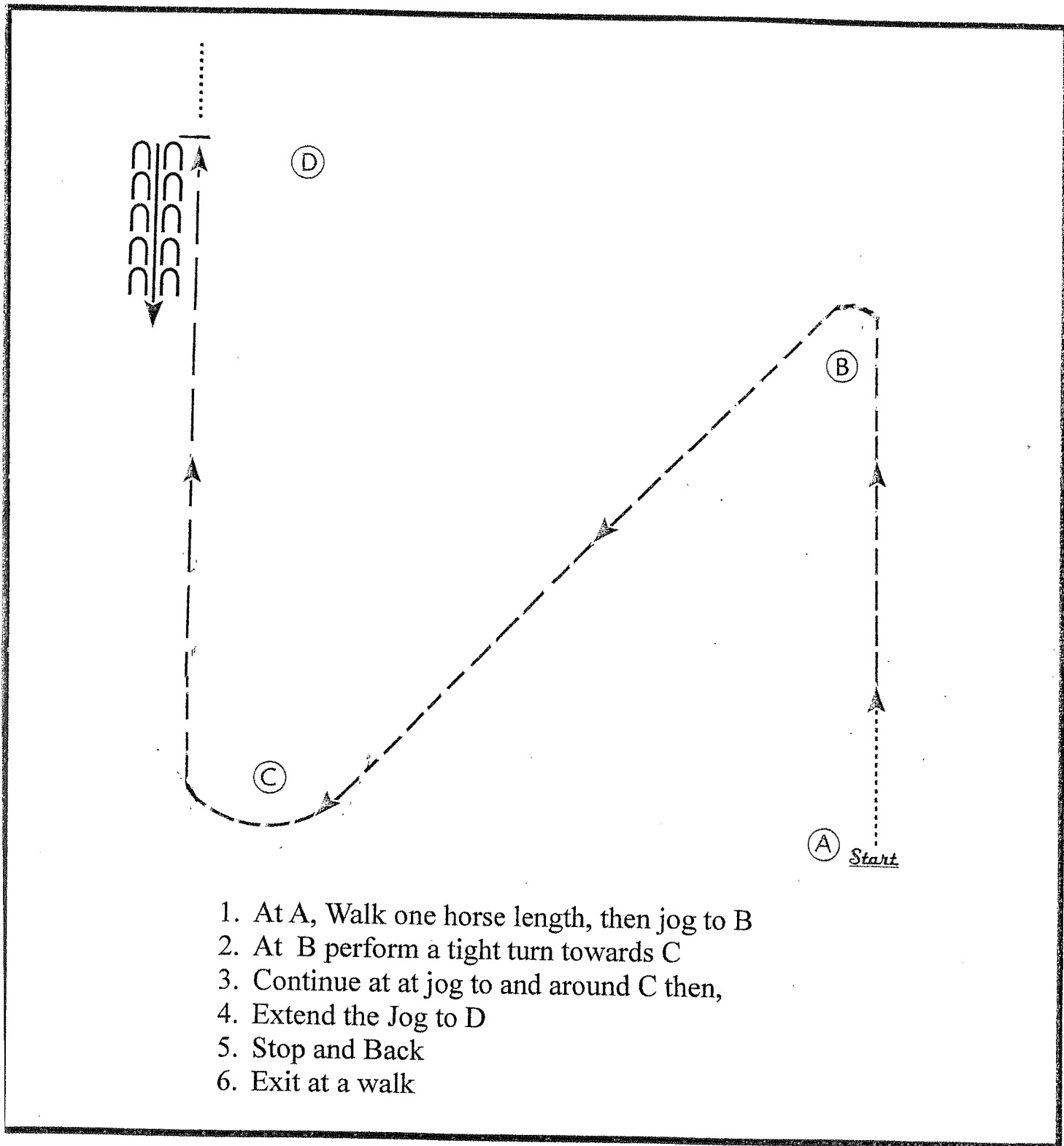

Pattern Provided by:

The Judges

Level 1 Youth/Amateur Horsemanship

Show Date: 5-27

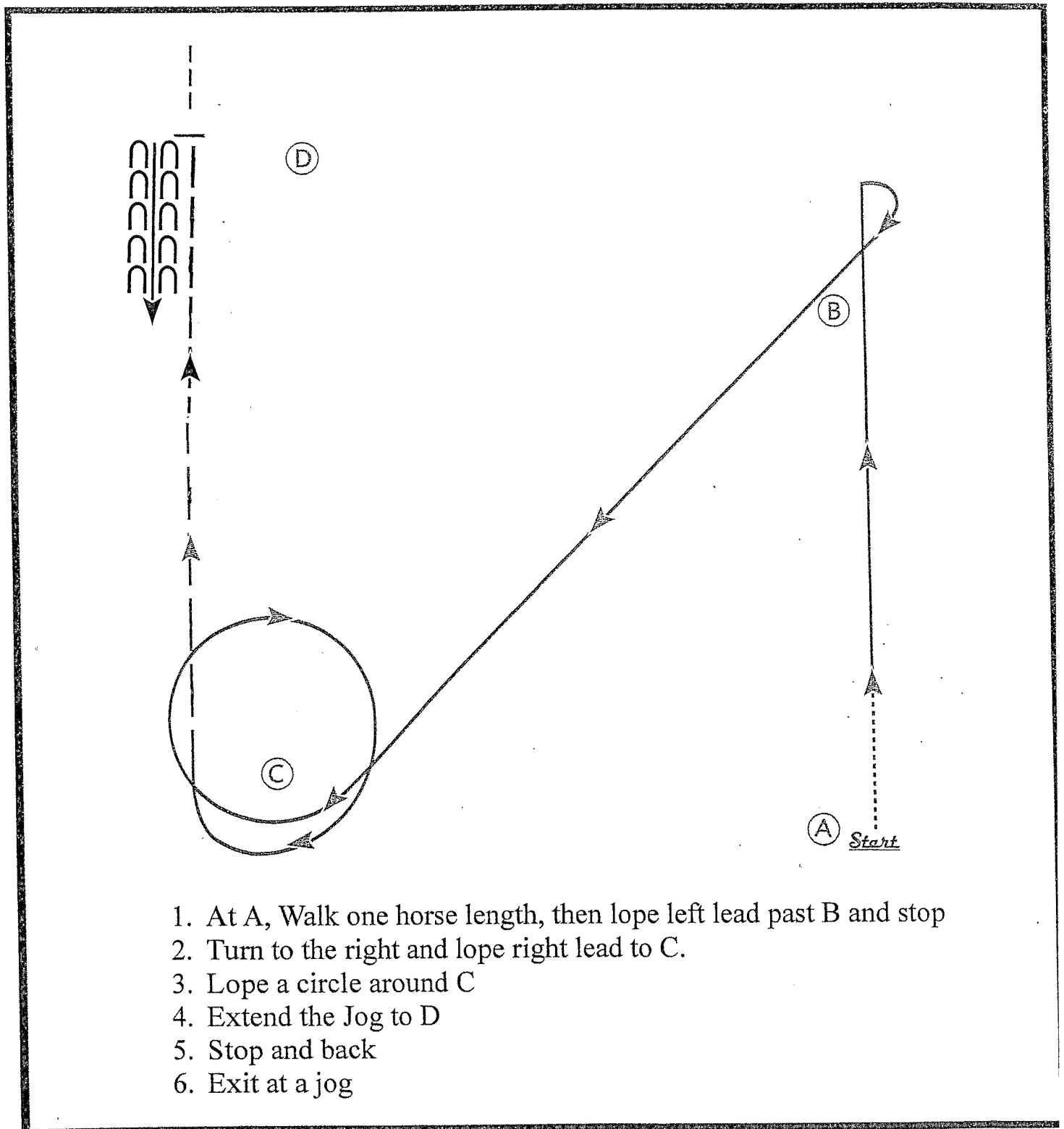

Pattern Provided by:

The Judges

All Ages Open Youth/Amateur Horsemanship

Show Date: 5-27

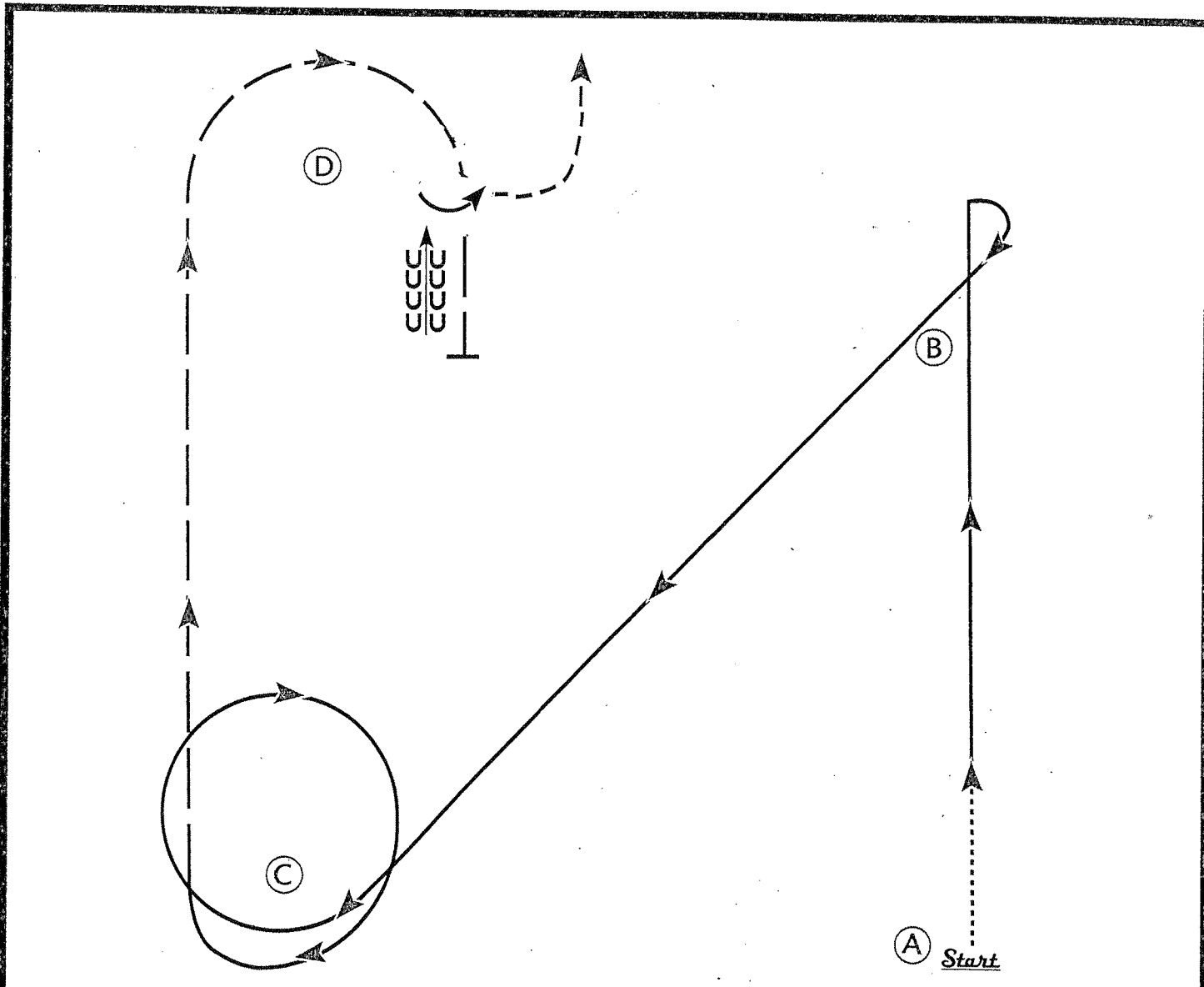

1. At A, Walk one horse length, then lope left lead past B
2. Rollback to the right and lope right lead to C.
3. Lope a circle around C
4. Extend the Jog to and around D
5. Stop and Back
6. 90 turn to the left, exit at a jog.

Pattern Provided by:
The Judges

May
27th
2019

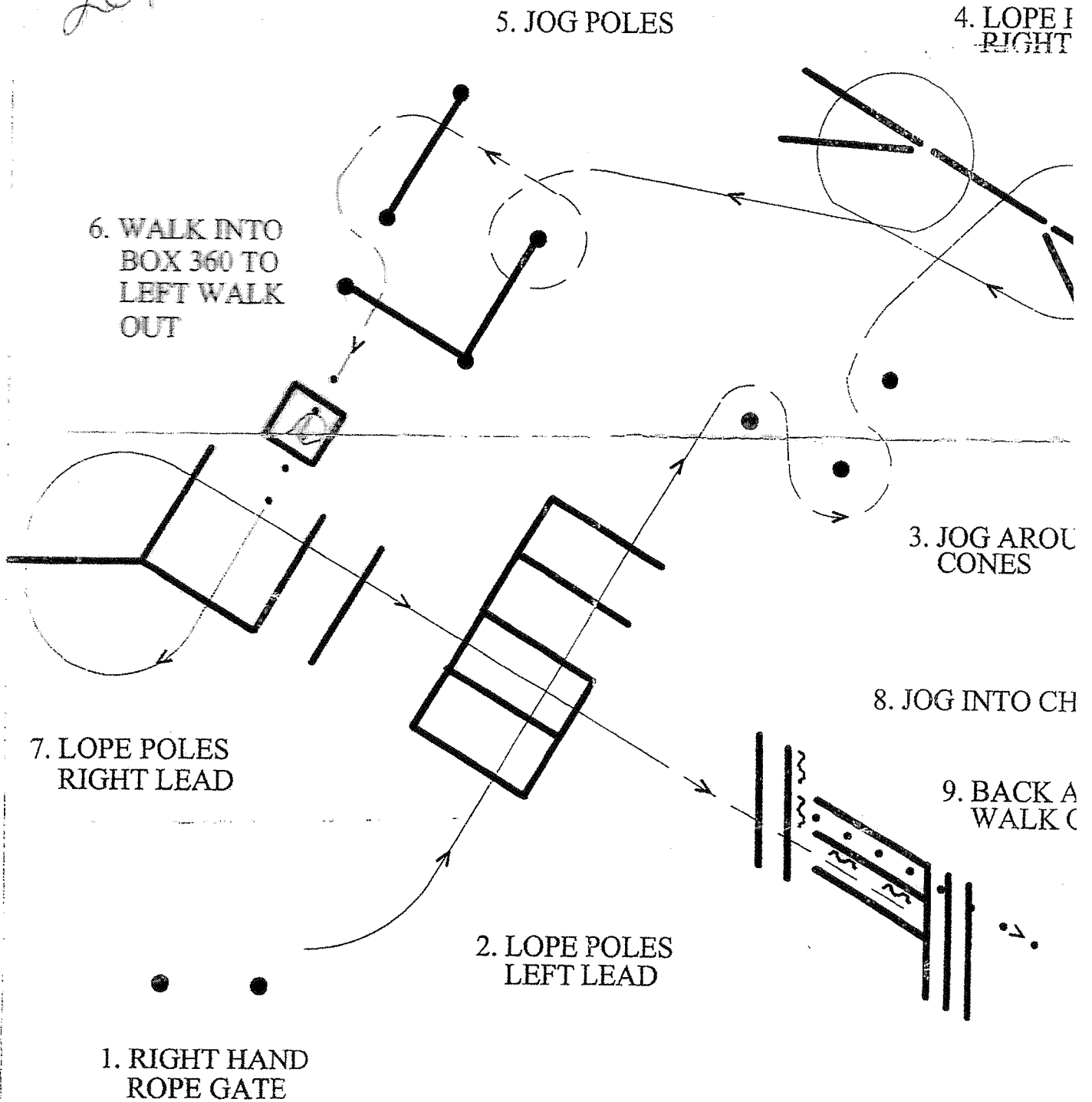

May
27th
2019

Small Fry

3. JOG POLES

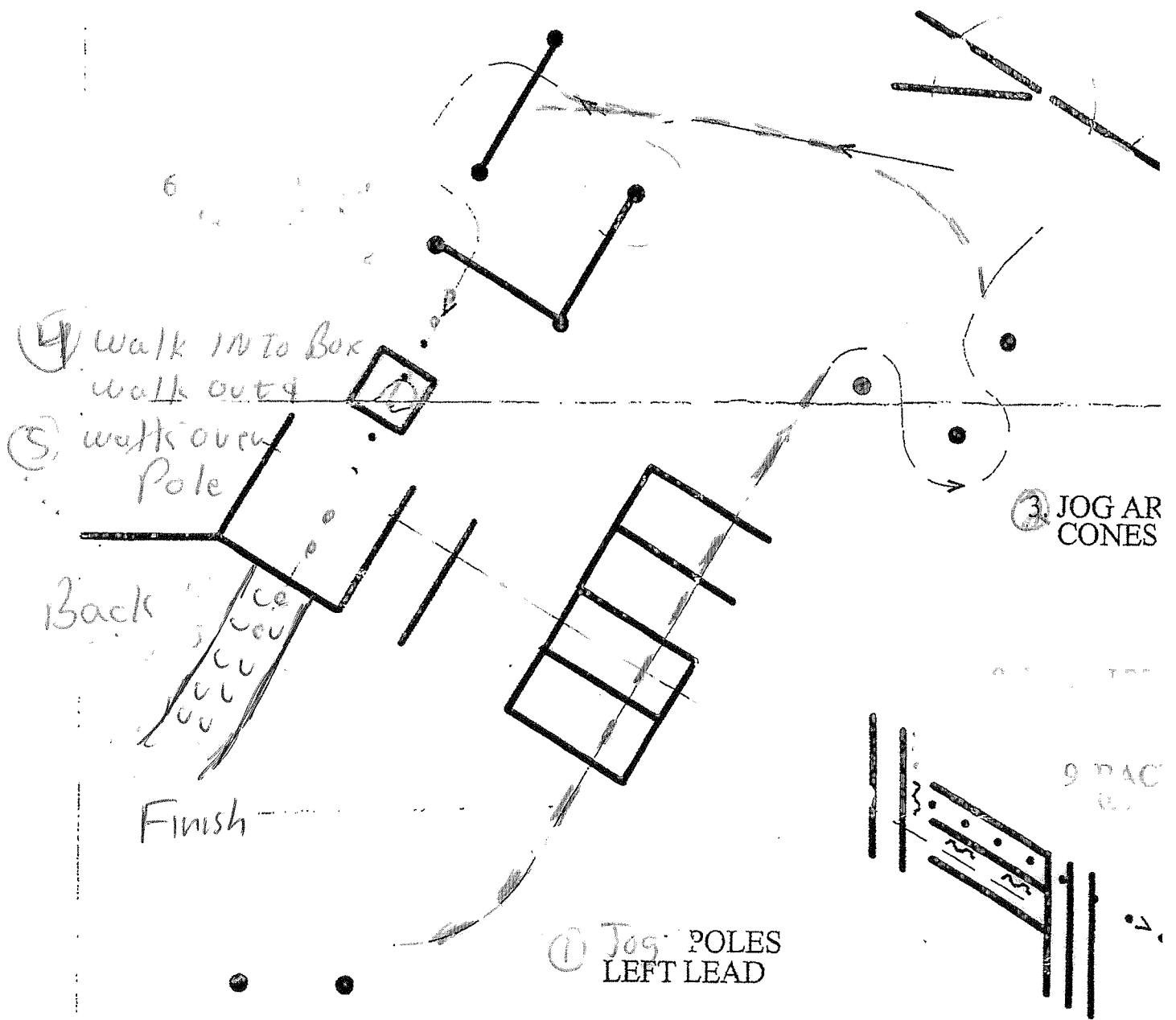

**EQUESTRIANS WITH DISABILITIES
SHOWMANSHIP (WALK ONLY)**

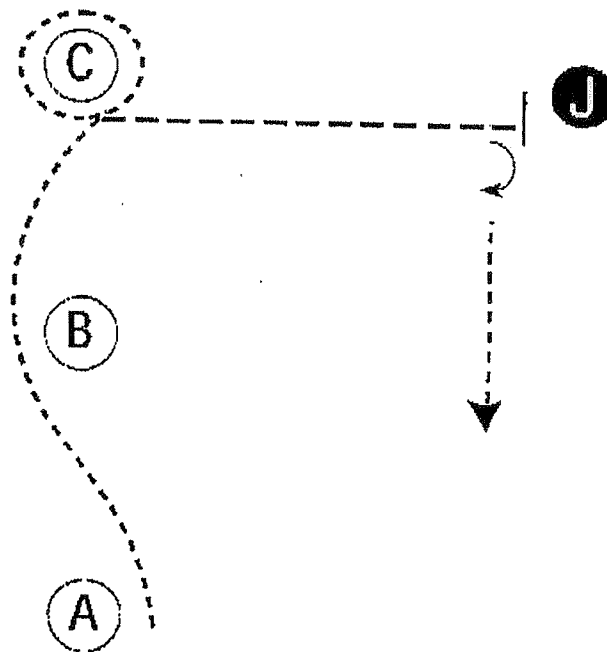

Be ready at A.

1. When acknowledged, walk from A, around B to C.
 2. Walk a tight circle around C.
 3. Walk to judge.
 4. Stop and set up for inspection.
 5. When dismissed, perform a 90 degree turn and walk away from judge.
- Follow the directions of your ring steward.

- Walk -----
Trot - - - - -
Back ←-----
Marker (B)
Judge (J)

EQUESTRIANS WITH DISABILITIES WESTERN HORSEMANSHIP (WALK-JOG)

Walk
Jog	-----
Extended Jog	-----
Lope	————
Leg Yield	
Lead Change	↗↘
Back	←←←←
Marker	⊙
Sidepass	←→

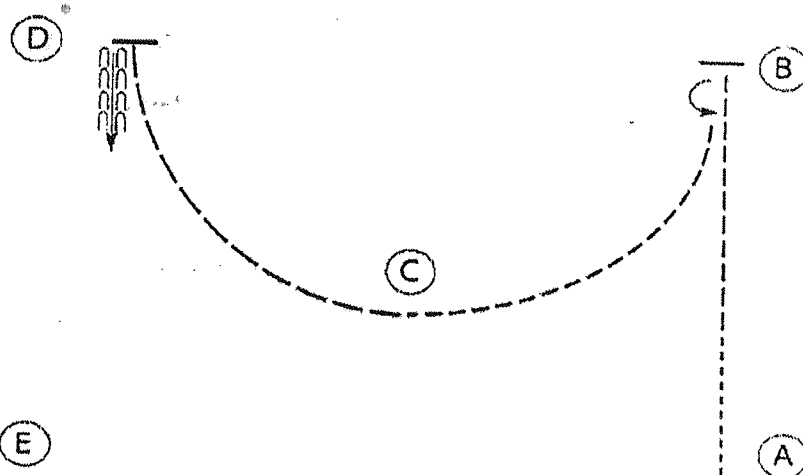

Be ready at A.

1. Walk approximately two strides from A.
 2. Jog to B.
 3. Stop and perform a 180 degree turn to the left.
 4. Jog a half circle to C.
 5. Extend the jog to D.
 6. Stop at D and back approximately one horse length.
- Follow the instructions of your ring steward.

EQUESTRIANS WITH DISABILITIES HUNT SEAT EQUITATION (WALK-TROT)

Walk
Trot	-----
Extended Trot	-----
Canter	————
Leg Yield	
Lead Change	↗↘
Back	←←←←
Marker	⊙
Sidepass	←→
Hand Gallop	-----

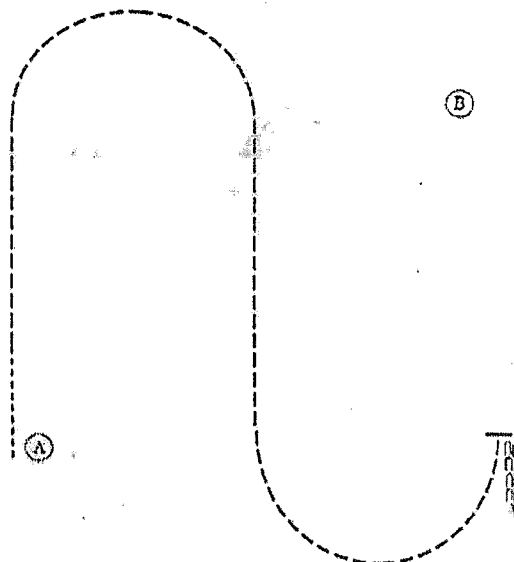

Be ready at A.

1. Walk two horse lengths from A.
2. Trot forward and a half circle on the left diagonal until even with B.
3. Change diagonal and trot straight and then a half circle on the right diagonal until even with A.
4. Stop and back approximately one horse length.

SATURDAY – May 27

Ranch Riding #2

Reining #1

Western Riding #2